

➤ Instructions

Thule FreeRide 532

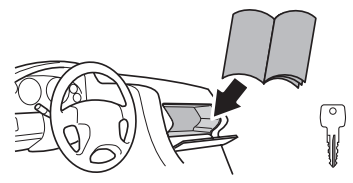

i

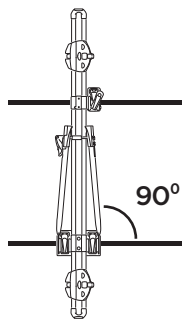
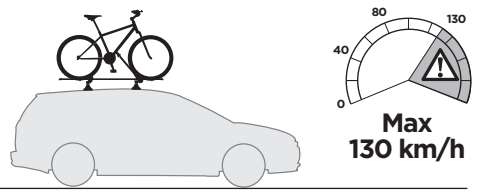
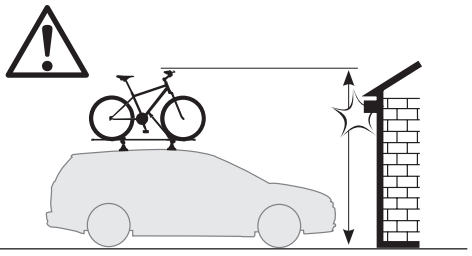
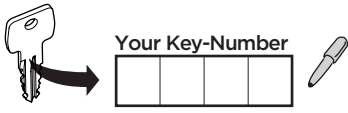

1

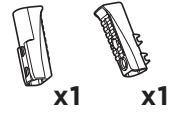
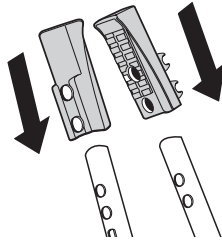

2

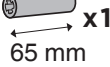
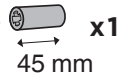

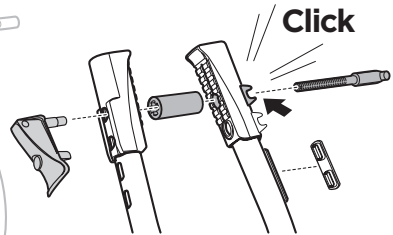
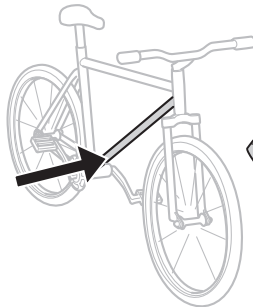

45 mm

 $\varnothing 22 - 58 \text{ mm}$



65 mm

 $\varnothing 59 - 70 \text{ mm}$
 80
 65
Max $65 \times 80 \text{ mm}$

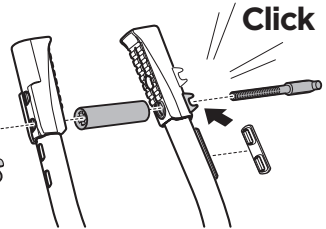
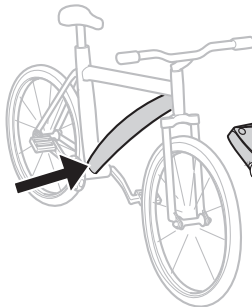

3

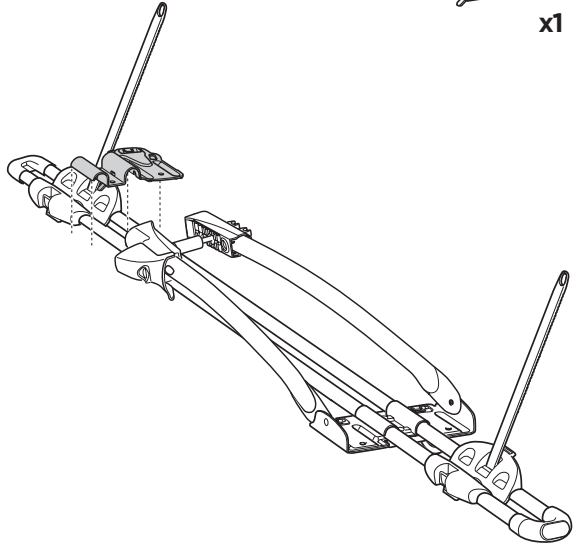
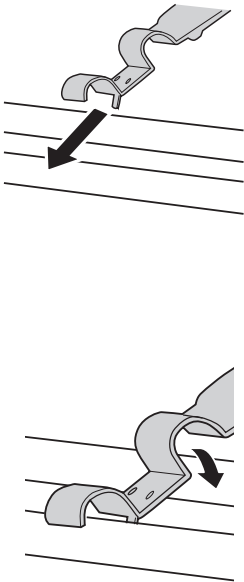

4

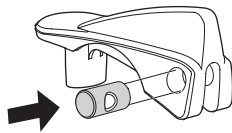
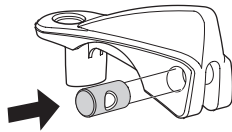

5

i

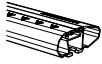

Thule WingBar Evo

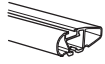

Thule WingBar



x1



x3

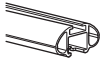

Thule AeroBar



Thule SlideBar



x2

A

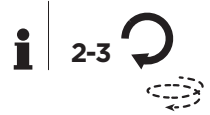
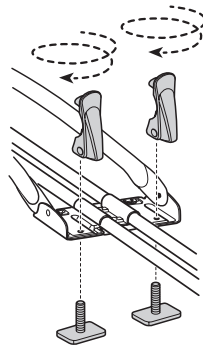
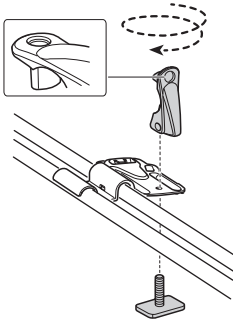

B

i



THULE WingBar Evo

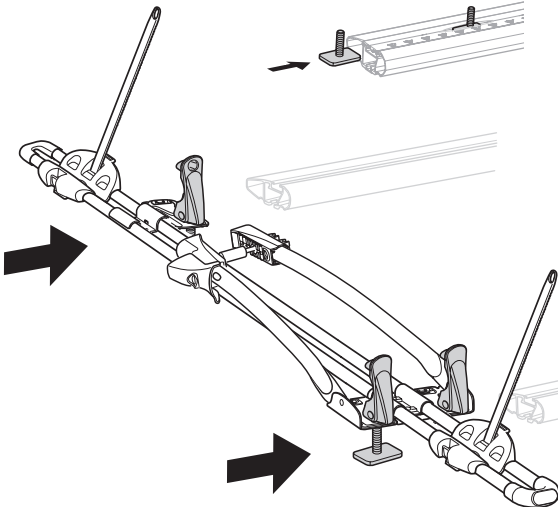
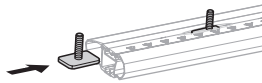

C

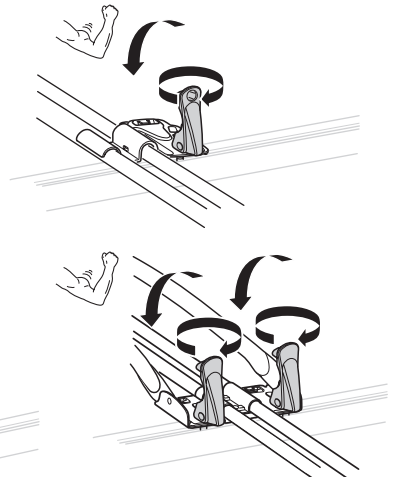

5

i

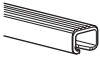

Thule SquareBar

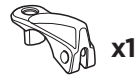

x1



x3



x2



x3

A

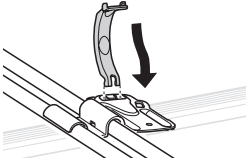

B

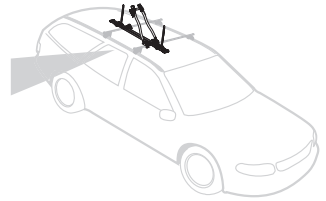
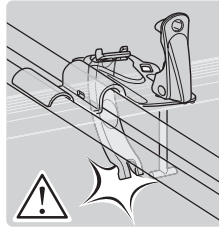
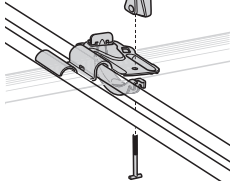

C

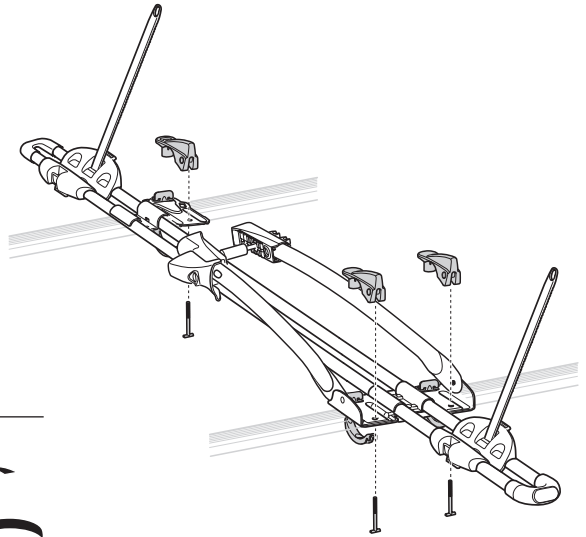
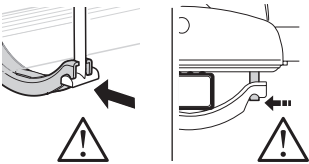

D

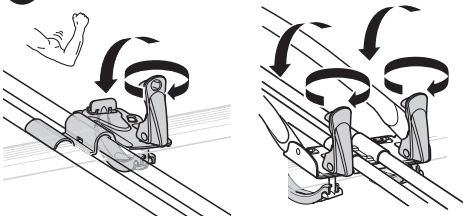

6

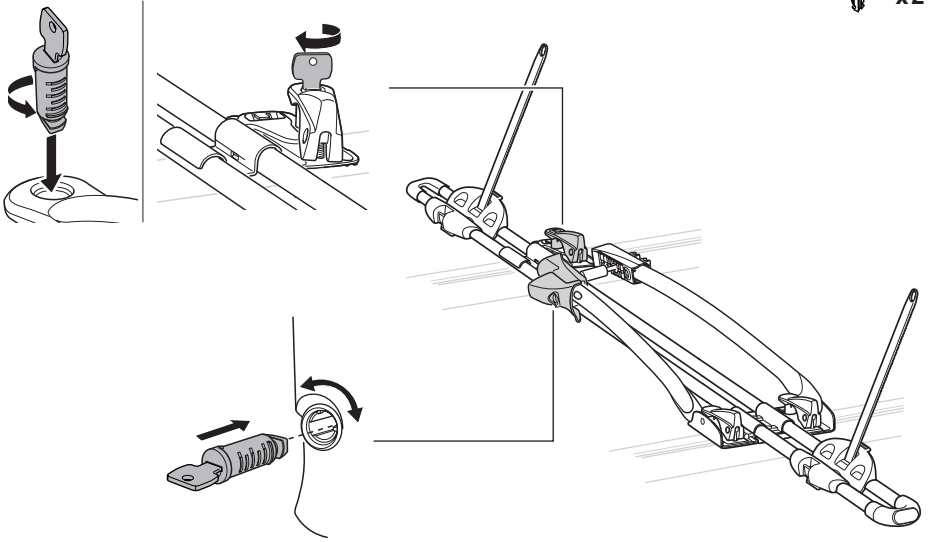

7

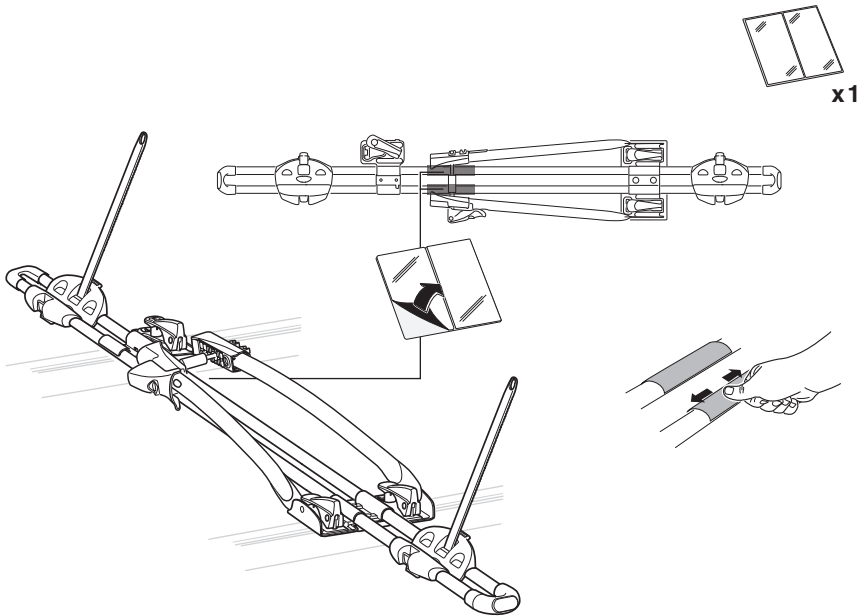

8

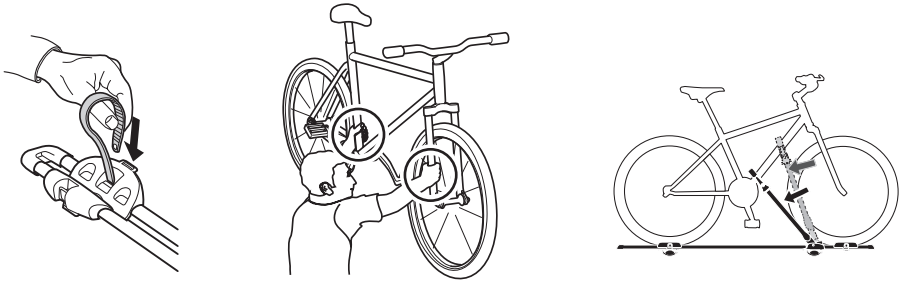

9

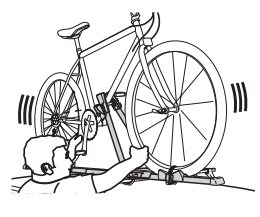
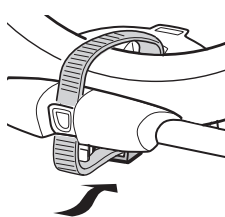
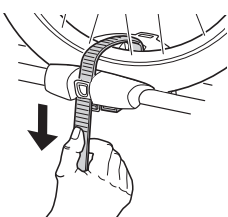
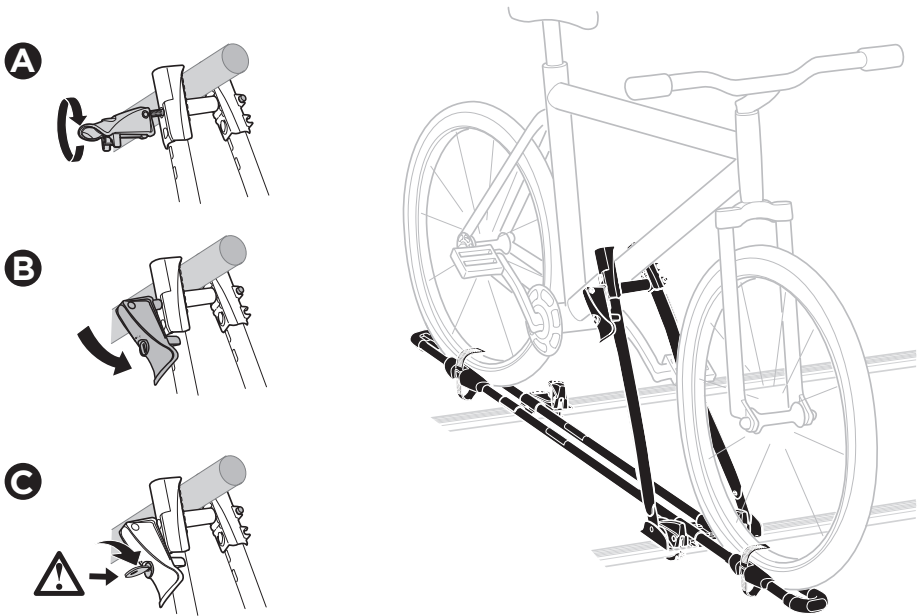

EN	Left-hand fitting	UK	Установка на ліву сторону		
DE	Montage links	BG	Монтаж отляво		
FR	Montage côté gauche	CS	Montáž z levé strany		
NL	Montage aan de linker kant	SK	Montáž na ľavej strane		
IT	Montaggio a sinistra	SL	Pritrjevanje z leve strani		
ES	Montaje a izquierda	HR/BIH	Montaža s lijeve strane		
PT	Montagem do lado esquerdo	RO	Montare pe partea stângă		
SV	Vänstermonterad	HU	Bal oldalról szerelhető		
DK	Venstremontering	EL	Τοποθέτηση αριστερά		
NO	Venstremontering	TR	Sol elle montaj		
FI	Asennus vasemmalle			התקנה שמאלית	HE
ET	Vasakpoolne kinnitamine			التركيب في الجانب الأيسر	AR
LV	Kreisais stiprinājums	ZH	从左侧安装		
LT	Kairysis pritvirtinimas	JA	左手装着		
PL	Montaż z lewej	KO	왼손 장착		
RU	Установка на левую сторону	TH	ตัวยึดด้านซ้ายมือ		

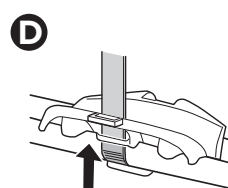
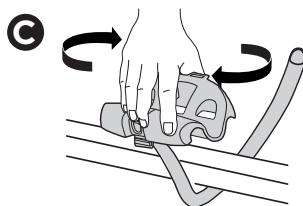
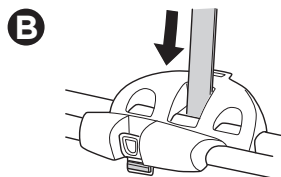
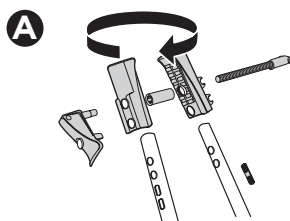
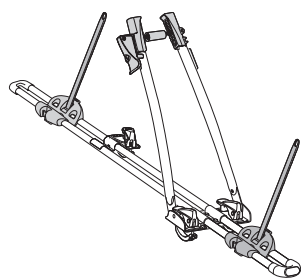

EN Accessories
DE Zubehör
FR Accessoires
NL Accessoires
IT Accessori
ES Accesorios
PT Acessórios
SV Tillbehör

DK Tilbehør
NE Tilbehør
FI Lisävarusteet
ET Lisavarustus
LV Piederumi
LT Priedai
PL Akcesoria
RU Аксессуары

UK Аксессуары
BG Принадлежности
CS Doplòky
SK Príslušenstvo
SL Dodatki
HR/BiH Dodaci
RO Accesorii
HU Tartozékok

EL Εξαρτήματα
TR Aksesuarlar
AR الملحقات
HE אביזרים
ZH 附件
JA アクセサリー
KO 액세서리
TH อุปกรณ์เสริม

Thule One-Key System

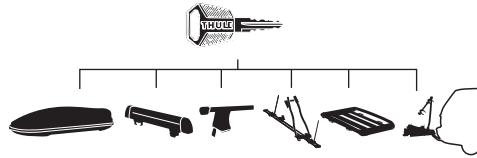

450400  (x4)

450600  (x6)

450800  (x8)

451200  (x12)

451600  (x16)

Thule Adapter 889-3

